

Universal Tilt LCD/LED TV Bracket

WMS07-44T 26"-55"

- Low-profile slim
- Solid design
- Screw Locking system for safety
- Bubble level includes



Family Line product



WMS07-22T TILT
VESA200X200 Max Load 35Kg
17"-42"



WMS07-22F FIXED
VESA200X200 Max Load 35Kg
17"-42"

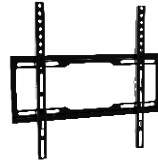

WMS07-44F FIXED
VESA400X400 Max Load 45Kg
26"-55"



WMS07-64T TILT
VESA600X400 Max Load 50Kg
37"-70"

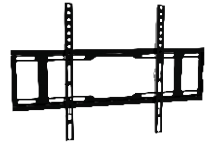

WMS07-64F FIXED
VESA600X400 Max Load 50Kg
37"-70"

Description

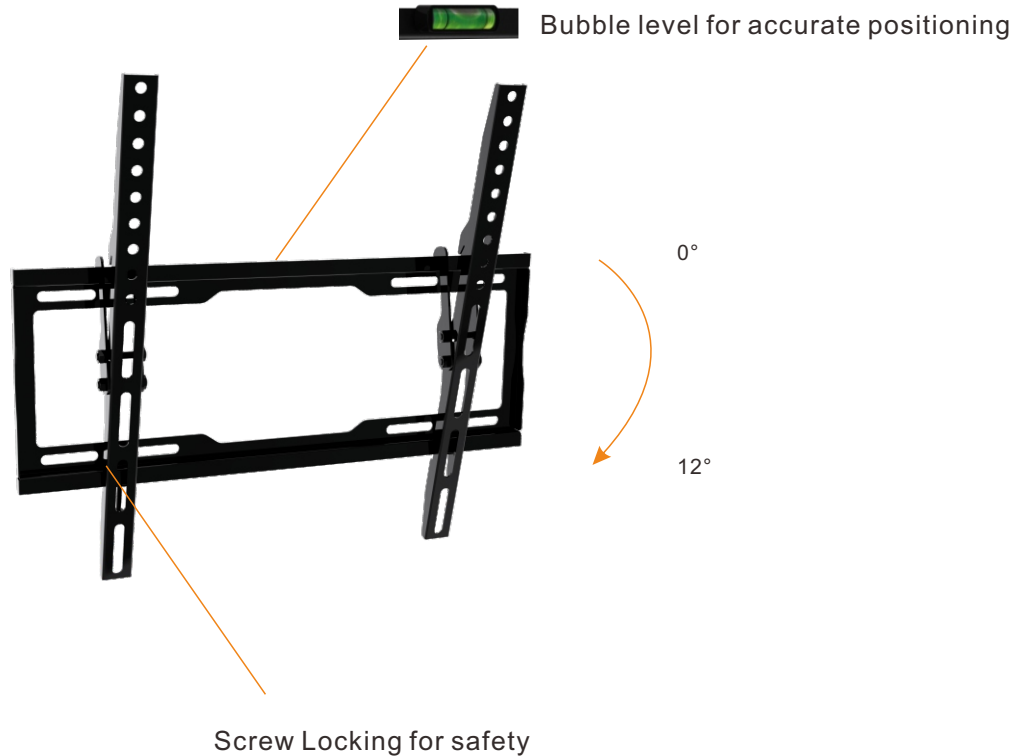

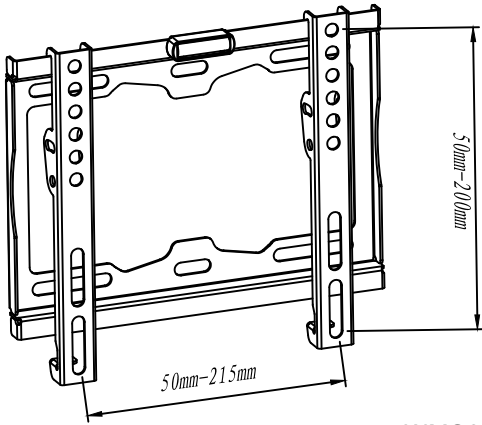

WMS07-22F

VESA 200x200(mm)	17"-42" Screen Sizes	Max Load 35kg/77lbs	Low Profile (mm) 27
----------------------------	--------------------------------	-------------------------------	-------------------------------

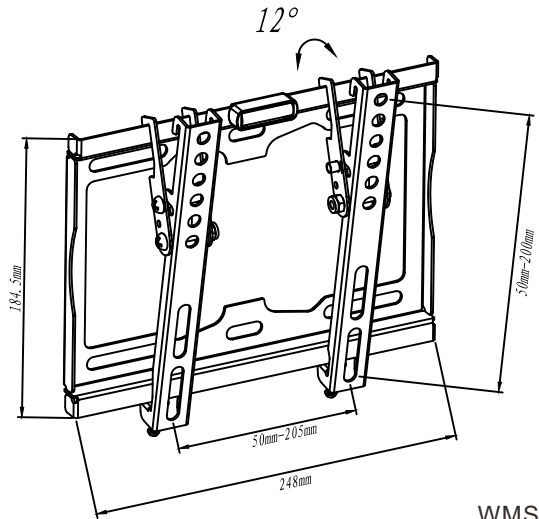

WMS07-22T

VESA 200x200(mm)	17"-42" Screen Sizes	Max Load 35kg/77lbs	Low Profile (mm) 30	Tilt Angle 0 to +12°
----------------------------	--------------------------------	-------------------------------	-------------------------------	--------------------------------

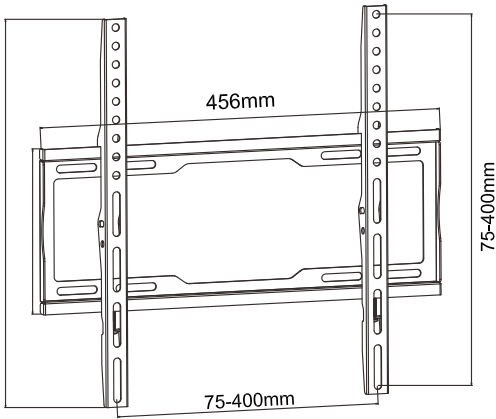

WMS07-44F

VESA 400x400(mm)	26"-55" Screen Sizes	Max Load 45kg/99lbs	Low Profile (mm) 27
----------------------------	--------------------------------	-------------------------------	-------------------------------

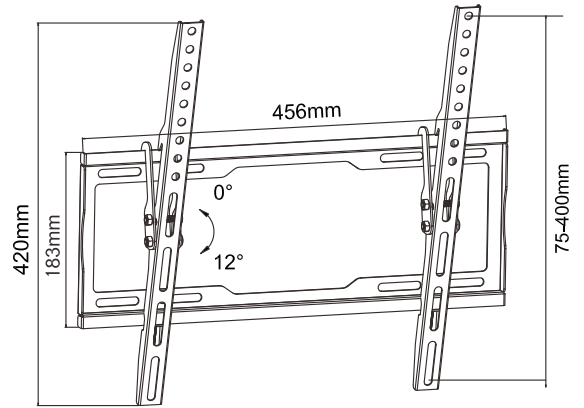

WMS07-44T

VESA 400x400(mm)	26"-55" Screen Sizes	Max Load 45kg/99lbs	Low Profile (mm) 30	Tilt Angle 0 to +12°
----------------------------	--------------------------------	-------------------------------	-------------------------------	--------------------------------

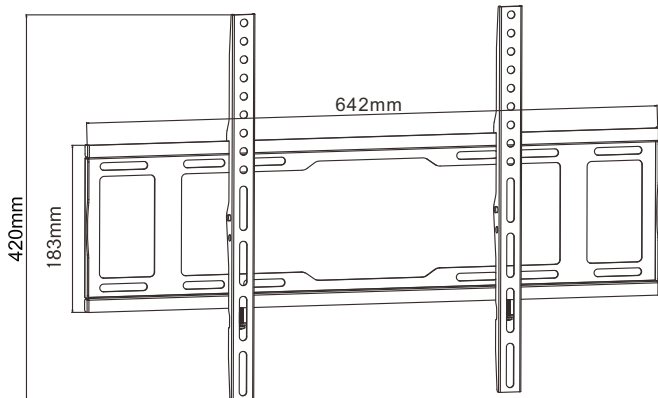

WMS07-64F

VESA 600x400(mm)	37"-70" Screen Sizes	Max Load 50kg/110lbs	Low Profile (mm) 27
----------------------------	--------------------------------	--------------------------------	-------------------------------

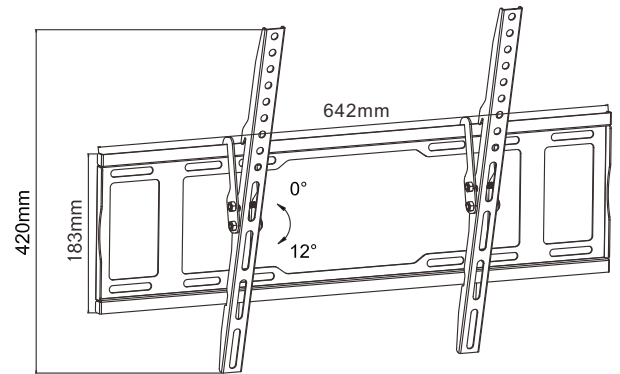

WMS07-64T

VESA 600x400(mm)	37"-70" Screen Sizes	Max Load 50kg/110lbs	Low Profile (mm) 30	Tilt Angle 0 to +12°
----------------------------	--------------------------------	--------------------------------	-------------------------------	--------------------------------